

WOLVES TENNIS

2019

CUT BANK INVITATIONAL

Havre Blue Ponies

Cut Bank Wolves

FERGUS EAGLES

CONRAD COWBOYS

CHOTEAU BULLDOGS

Boys & Girls Teams—WELCOME!

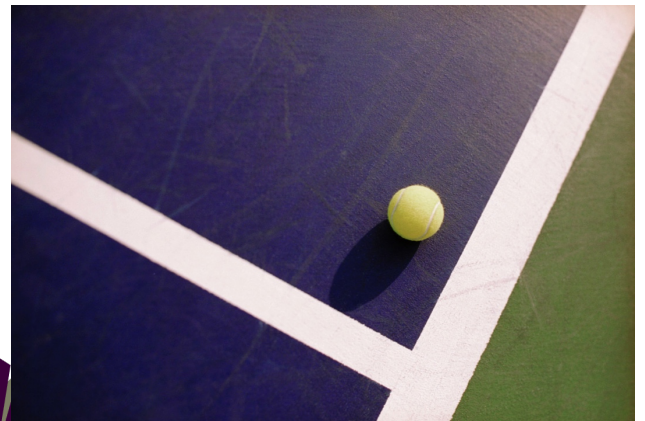

WOLVES INVITATIONAL TENNIS

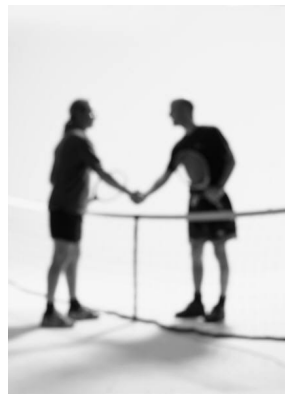

Sportsmanship-

James O. Gregg - Coach
PAUL SCHILLING - Asst. Coach
Cut Bank High School



Cut Bank Invitational Tennis Matches

Teams: **Cut Bank, Conrad, Fergus, Havre & Choteau**
Date: **March 23, 2019**
Location: **Cut Bank Courts & Willie DeGroot Gymnasium Courts**

Dear Coaches & AD's,

Welcome back for another great year of tennis and we are looking forward to hosting your teams once again at our Invitational Tennis matches! With a little luck and cooperation from Momma Nature, we will utilize six courts this year, we plan to use the tournament format with brackets for Girls' No. 1 & 2 Singles, Girls' No. 3 & 4 Singles, Girls' Doubles 1-2, Girls' Doubles 3, Boys' No. 1 & 2 Singles, Boys' No. 3 & 4 Singles, Boys' Doubles 1-2 and Boys' Doubles 3. We will play the Singles 1 & 2's and Doubles on the outdoor courts and the Singles 3 & 4's on the indoor courts. There might be some shuffling of matches to keep the tournament moving and utilize open courts. However, things might run quick and smoothly. The weather forecast is always questionable. Right now the forecast is..... Make sure your kids are prepared for cold weather if playing outdoors. You must get me your number of participants and names ready by Wednesday evening, March 20th. I will put the brackets together once I have your entries.

I will post the brackets on our website once the tournament is setup. We plan to start at 8:00 am on Saturday morning. You can email me your rosters at elemjg@cutbankschools.net or jimg@bresnan.net. You should have 4 singles and 3 doubles on your roster.

All matches will be played with NO-ADD scoring in a 6-game PROSET format. We will play a 12-point tiebreak at 5 games all (contingent on numbers – we may be able to increase this?) Warm-ups, including serves are limited to 5 minutes. Time permitting; we may be able to adjust the scoring format for semi-final and final matches.

Bathroom facilities are located at the North end of Anna Jeffries School and in the lobby of the High School. Please remind your players **NOT** to enter any other areas at Anna Jeffries School or the locker rooms at the High School. Please help us keep our facilities clean and thank you for your help with this!

All final results will be posted on the Wolves' Tennis site. You can view the results of the matches at the following URL address:
http://www.cutbankschools.net/hs/Tennis_site/wolves1.htm

We hope you enjoy the tennis and we look forward to providing you and your players with an awesome day of competition as long as the early March weather will cooperate. Good luck to all! Again, Welcome Back to another GREAT season of HIGH SCHOOL TENNIS!

If you are not a member of the Montana High School Tennis Coaches Association, please consider joining. You can get additional information from our website: <http://www.mhstca.com>
Also, if you are not a member of the Montana Coaches Association, you should consider joining. The MCA offers a lot of resources for Montana Coaches and awards Coach of the Year status to members only.

-Coach Gregg-

PRIDE, SPORTSMANSHIP & TRADITION



Cut Bank Tennis Invitational – 2019 Match Schedule

CUT BANK INVITATIONAL TENNIS TOURNAMENT - 2019

Times are tentative @ Best	Court 1 Boys' 1/2 Singles	Court 2 Girls' 1/2 Singles	Court 3 Boys' Doubles	Court 4 Girls' Doubles	Court 5 Boys' 3/4 Singles	Court 6 Girls' 3/4 Singles
8:00-8:30	BS1	GS1	BD1/2-1	GD1/2-1	BS1	GS1
8:35-9:35	BS2	GS2	BD1/2-2	GD1/2-2	BS2	GS2
9:40-10:10	BS3	GS3	BD1/2-3	GD1/2-3	BS3	GS3
10:15-10:45	BS4	GS4	BD1/2-4	GD1/2-4	BS4	GS4
10:50-11:20	GD3-3	GS5	BD3-1	GD3-1	BS5	GS5
11:25-11:55	GD3-4	GS6	BD3-2	GD3-2	BS6	GS6
12:00-12:30	BS5	GS8	BD1/2-5	GD1/2-5	BS8	GS8
12:35-1:05	BS6	GS9	BD1/2-6	GD1/2-6	BS9	GS9
1:10-1:40	BS8	GD3-5	BD3-3	BD3-4	BS10	GS10
1:45-2:15	BS9	GD3-6	BD3-5	BD3-6	BS11	GS11
2:20-2:50	GD3-8	GD3-9	BD1/2-8	GD1/2-8	BS7 PRO8	GS7 PRO8
2:55-3:25	GD3-10	GD3-11	BD1/2-9	GD1/2-9	BS12 PRO8	GS12 PRO8
3:30-4:00	BS10	GS10	BD1/2-10	GD1/2-10	BD3-8	BD3-9
4:05-4:35	BS11	GS11	BD1/2-11	GD1/2-11	BD3-10	BD3-11
4:40-5:25	BS7	GS7	BD1/2-7	GD1/2-7	GD3-7	GD3-12
5:25-6:10	BS12	GS12	BD1/2-12	GD1/2-12	BD3-7	BD3-12

Matches in **Yellow** are Championship Matches and Matches in **Grey** are Consolation or 3rd and 4th place finals.

^^

THESE ARE THE
INDOOR COURTS @ HS GYM

COURTS 1-4 ARE LOCATED OUTDOORS BS1=Boys' Singles #1&2 etc.

96 matches.....

**2019 CUT BANK
INVITATIONAL TENNIS
GIRLS' SINGLES #1 & #2's
CHAMPIONSHIP BRACKET**

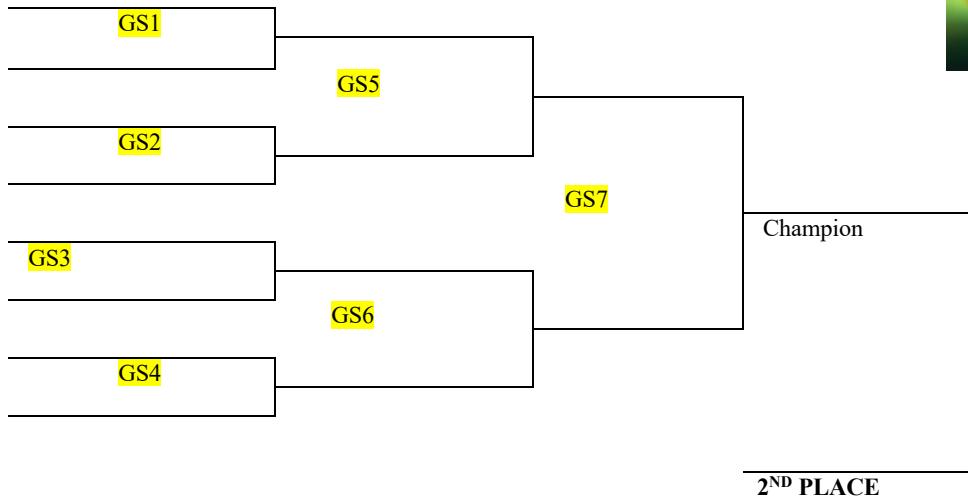
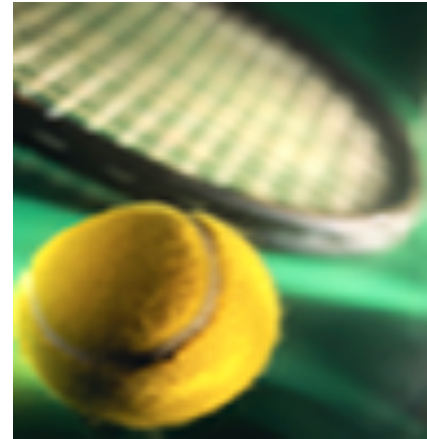

CONSOLATION BRACKET

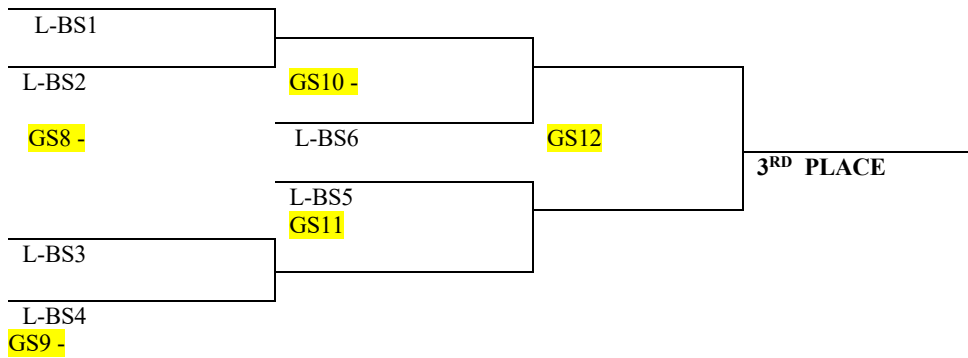

PRIDE, SPORTSMANSHIP & TRADITION

2019 CUT BANK
INVITATIONAL TENNIS
GIRLS' SINGLES #3 & #4's
CHAMPIONSHIP BRACKET

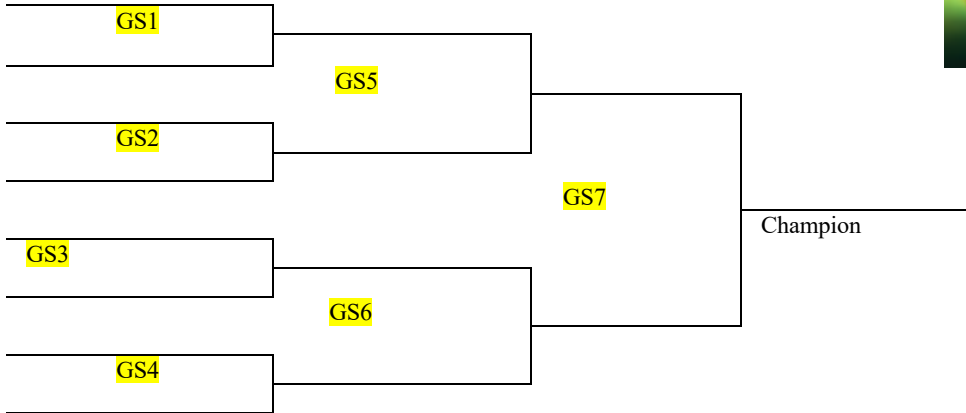
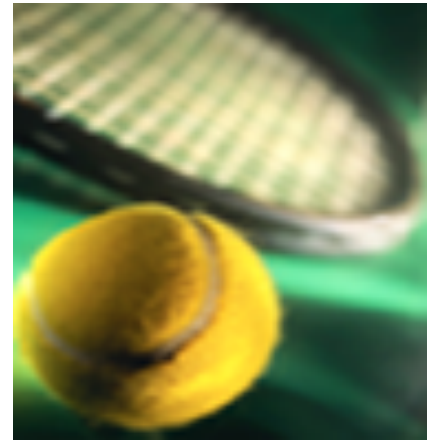

2ND PLACE

CONSOLATION BRACKET

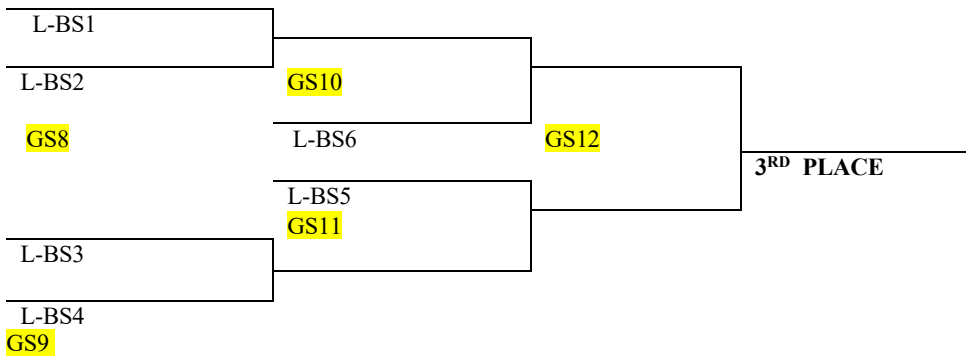

PRIDE, SPORTSMANSHIP & TRADITION

**2019 CUT BANK
INVITATIONAL TENNIS
GIRLS' DOUBLES 1 & 2
CHAMPIONSHIP BRACKET**

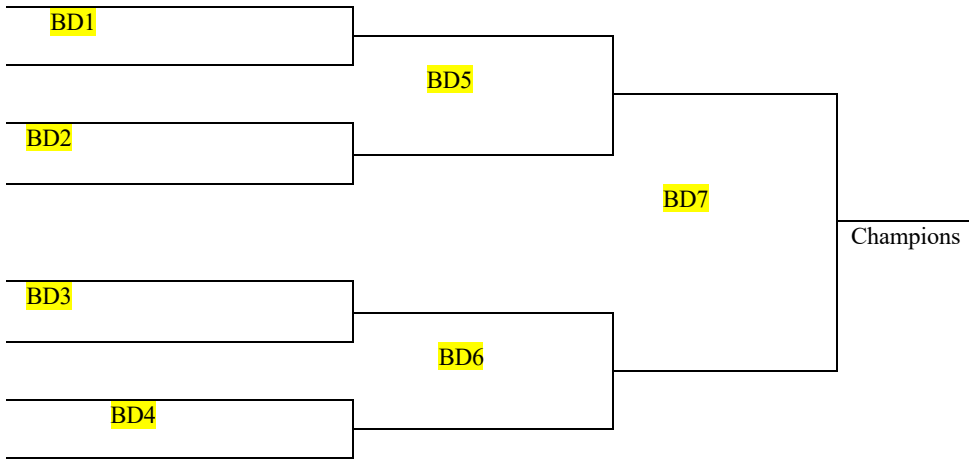
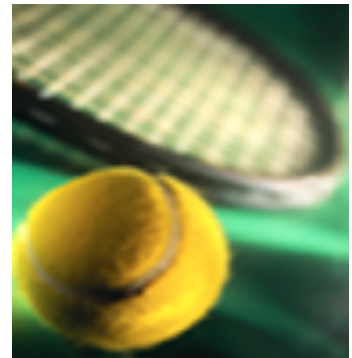

**CONSOLATION
BRACKET**

2ND
PLACE

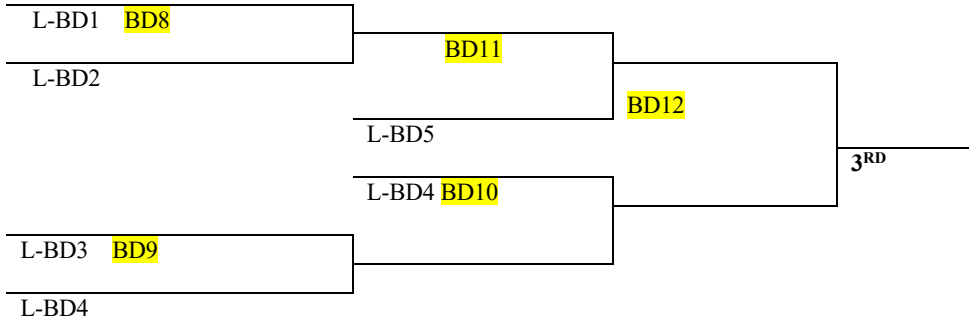

PRIDE, SPORTSMANSHIP & TRADITION

**2019 CUT BANK
INVITATIONAL TENNIS
GIRLS' DOUBLES 2 & 3
CHAMPIONSHIP BRACKET**

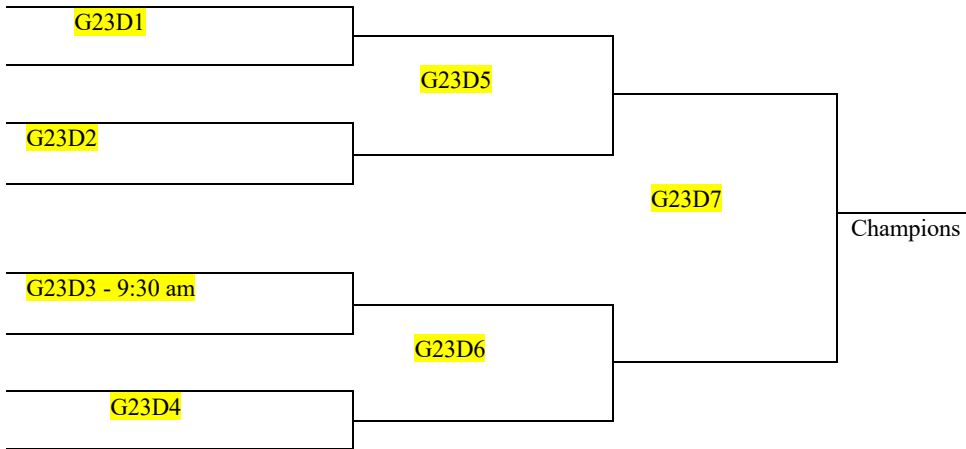
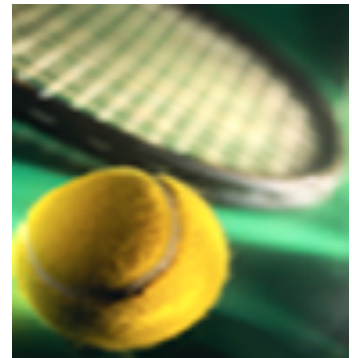

**CONSOLATION
BRACKET**

2ND
PLACE

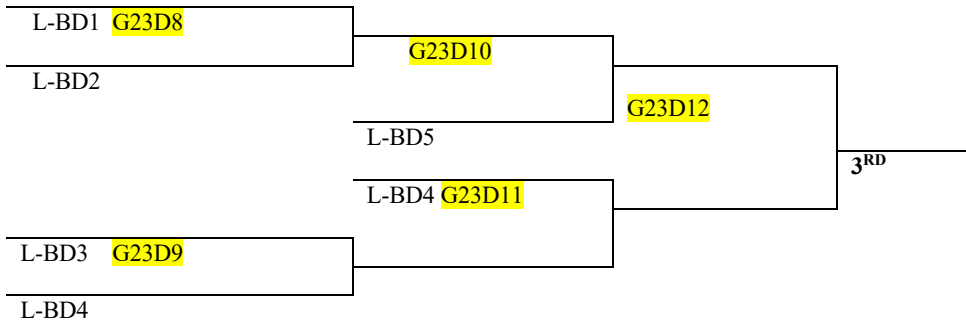

PRIDE, SPORTSMANSHIP & TRADITION

**2019 CUT BANK
INVITATIONAL TENNIS
BOYS' SINGLES #1 & #2's
CHAMPIONSHIP BRACKET**

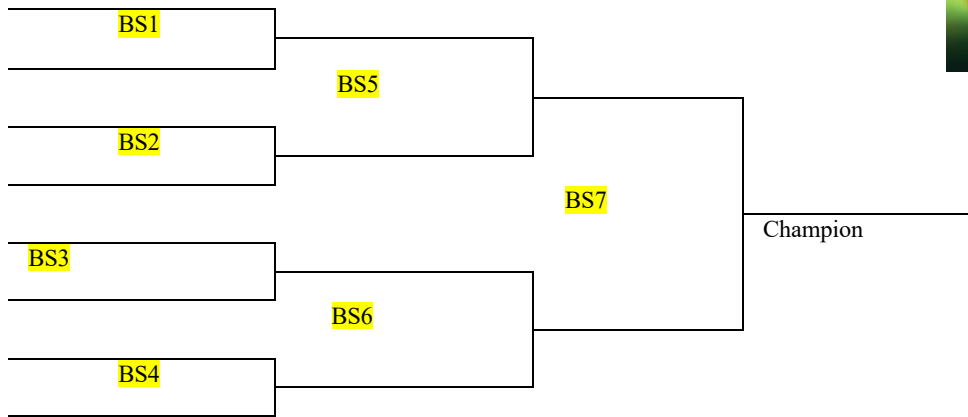
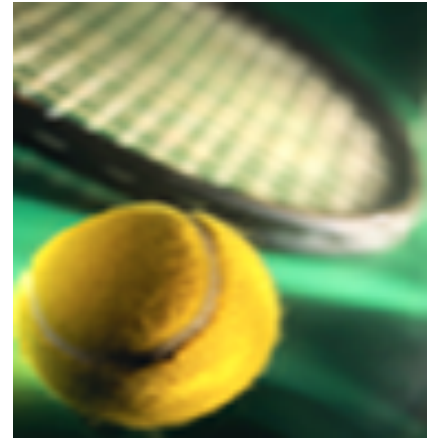

2ND PLACE

CONSOLATION BRACKET

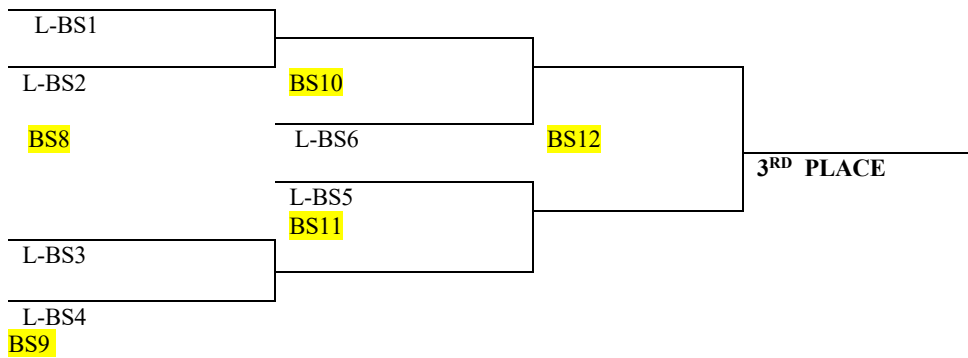

PRIDE, SPORTSMANSHIP & TRADITION

**2019 CUT BANK
INVITATIONAL TENNIS
BOYS' SINGLES #3 & #4's
CHAMPIONSHIP BRACKET**

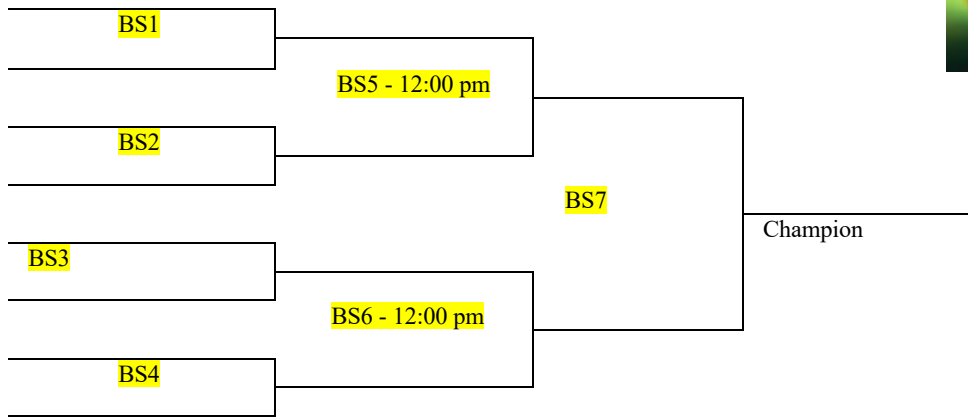
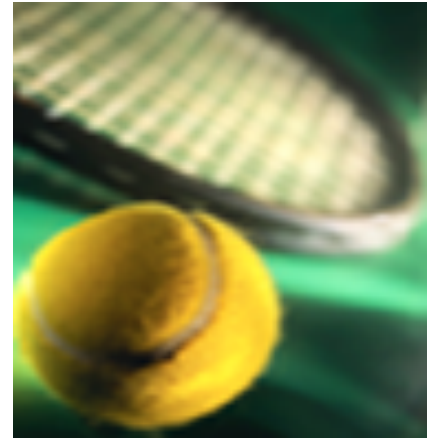

2ND PLACE

CONSOLATION BRACKET

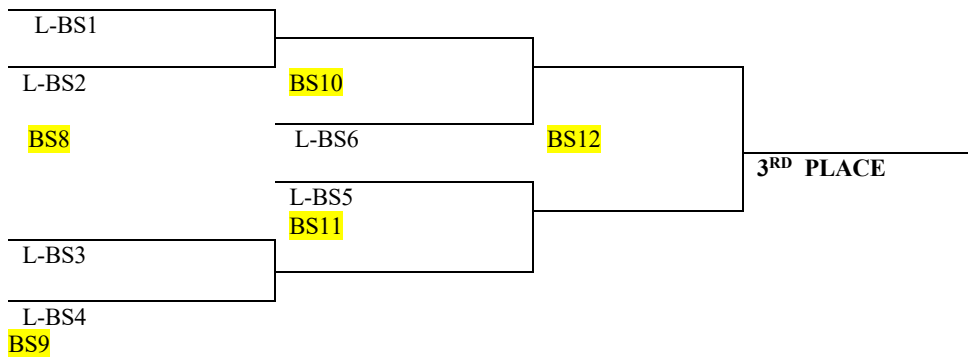

PRIDE, SPORTSMANSHIP & TRADITION

**2019 CUT BANK
INVITATIONAL TENNIS
BOYS' DOUBLES 1&2
CHAMPIONSHIP BRACKET**

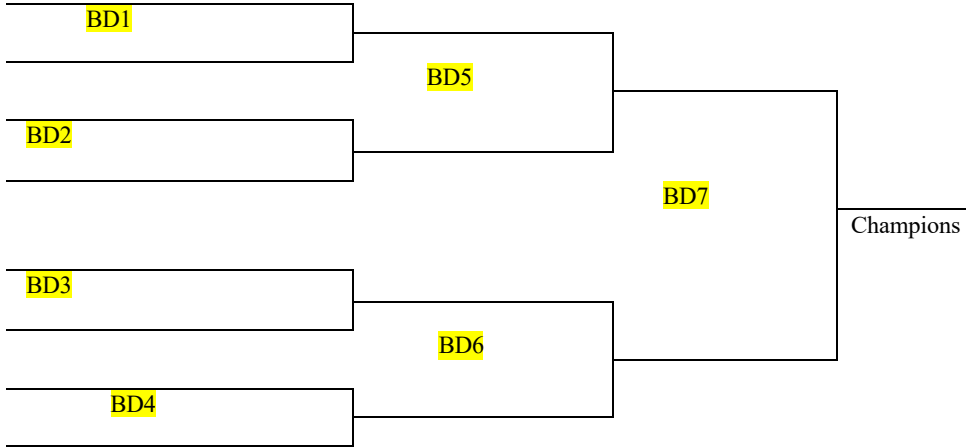
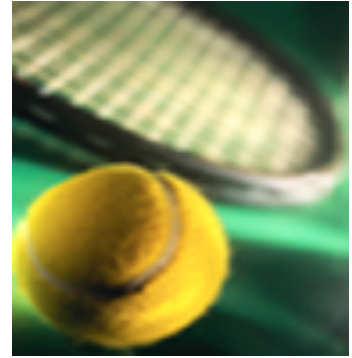

**CONSOLATION
BRACKET**

2ND
PLACE

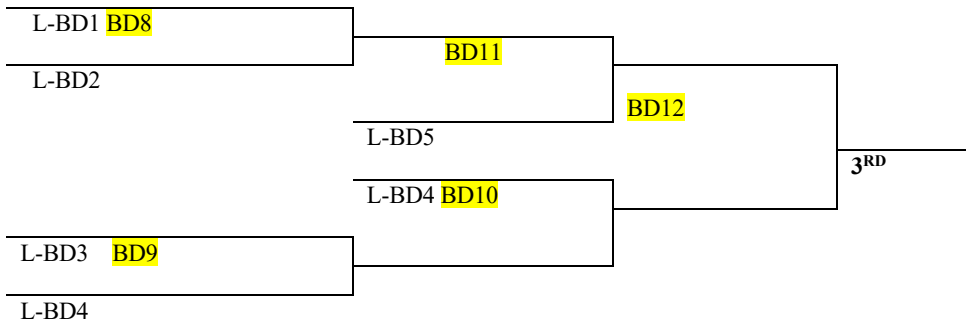

PRIDE, SPORTSMANSHIP & TRADITION

**2019 CUT BANK
INVITATIONAL TENNIS
BOYS' DOUBLES 2 & 3
CHAMPIONSHIP BRACKET**

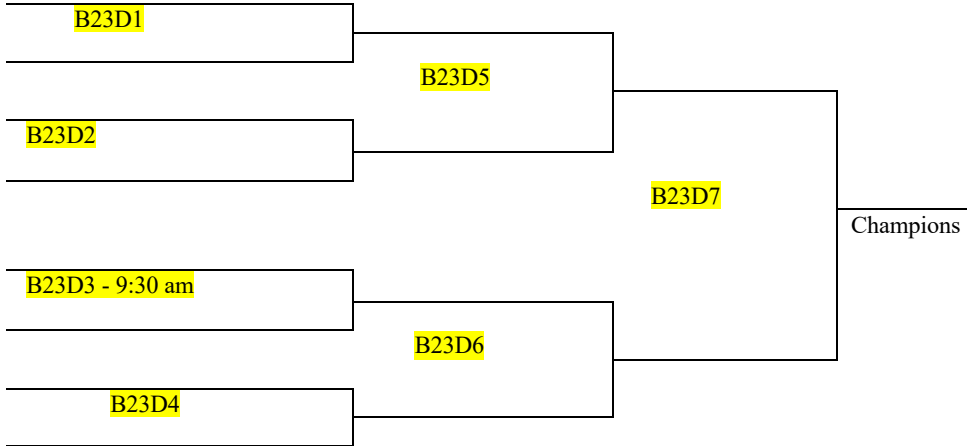
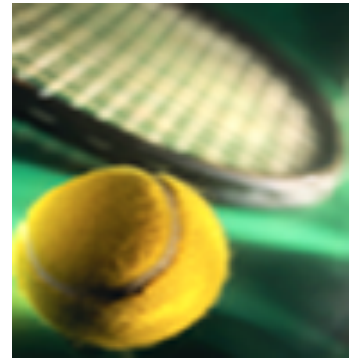

**CONSOLATION
BRACKET**

2ND
PLACE

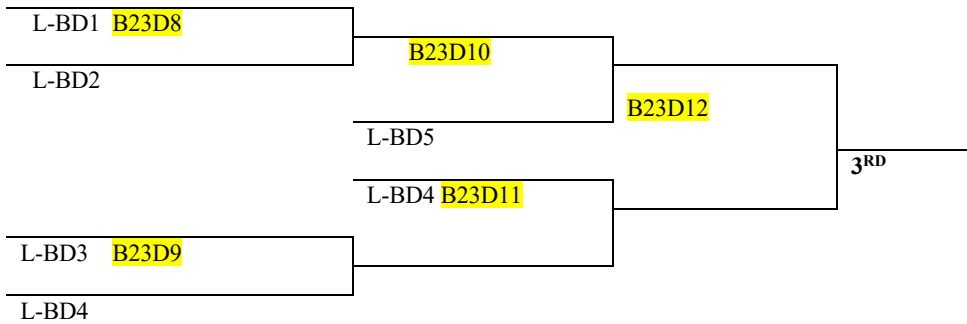

PRIDE, SPORTSMANSHIP & TRADITION